

DATA SHEET

General Characteristics

Standardcharge

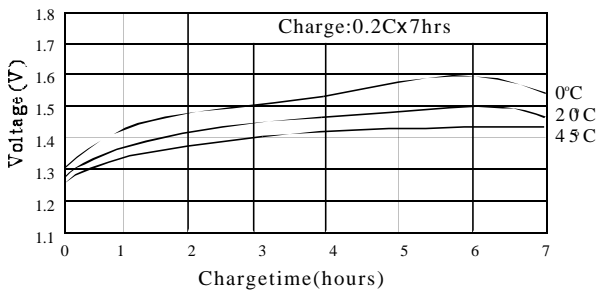

Fastcharge

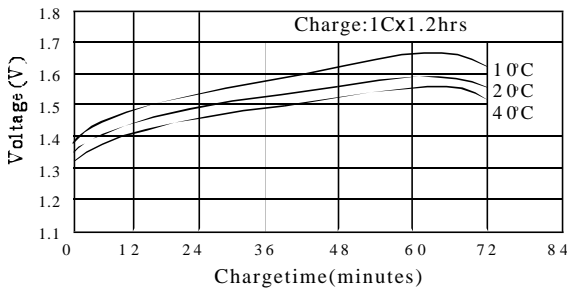

Dischargecharacteristicat 20°C

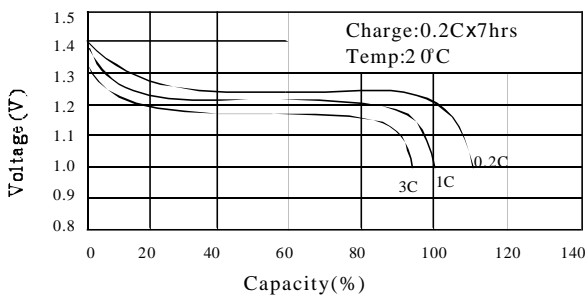

Cycle life

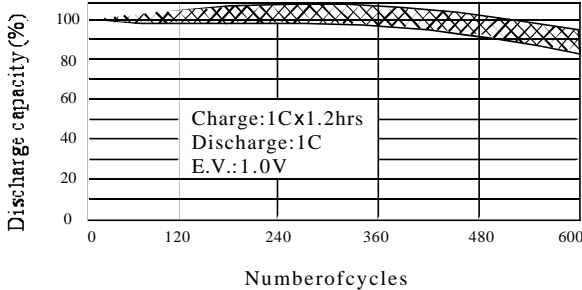

Specifications

Nominal Voltage		1.2V	
Capacity (mAh)		C/5	1C
	Nominal	1200	1100
	Typical	1300	1200
Dimension	Diameter	13.9±0.2mm	
	Height	42.5±0.3mm	
Approx Weight		24g	
Internal Resistance (at 1KHz)		≲25mΩ (full charged)	
Charge	Standard	240mA x 7hrs	
	Fast	1200mA x 1.2hrs	
	Trickle	3-60mA	
Discharge Cut-off Voltage		1.0V	
Cycle Life		≳500	
Ambient Temperature	Standard Charge	0-50°C	
	Fast Charge	10-50°C	
	Trickle Charge	0-45°C	
	Discharge	-20-60°C	
	Storage	-20-45°C	
Relative Humidity		65±20%	

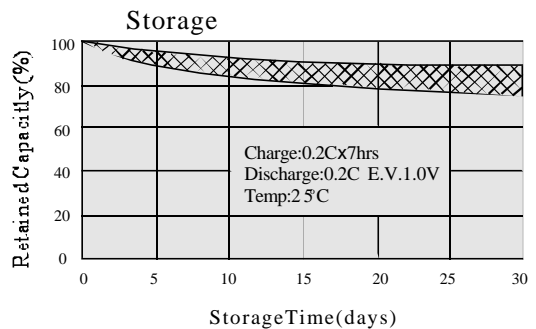
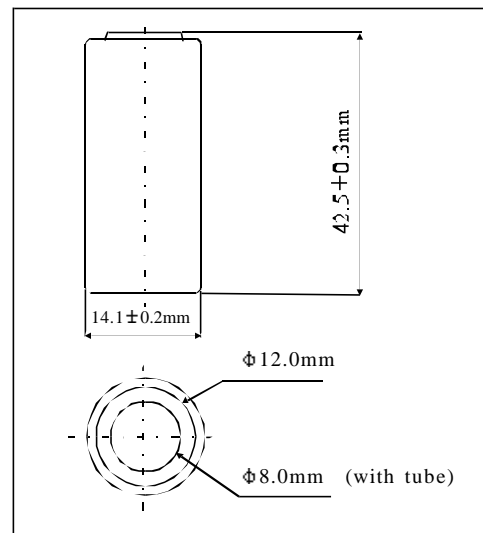

Note:

- 1. Nominal capacity rated at C/5, 20°C
- 2. Other capacities are for reference.
- 3. Weight and internal resistance are for reference.