

Manganese Dioxide Lithium Battery(Li/MnO₂)

MODEL: CR14250

Nominal capacity (3mA to 2.0V)	600 mAh
Nominal voltage	3.0 V
Max. Continuous operating current	100 mA
Max. pulse current	400 mA
Battery weight	9 g
Battery Dimension mm	$\phi 14.0^{\pm 0.2} \times 25.0^{-0.2}$
operating temperature	-40°C~+60°C

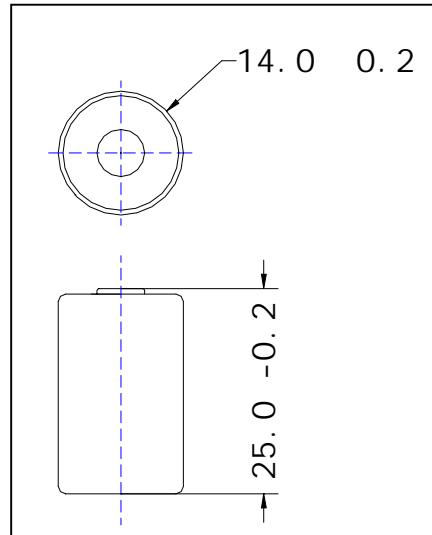

Notes: All dimensions are in mm.
Tolerance is ± 0.3 mm.

Characteristics

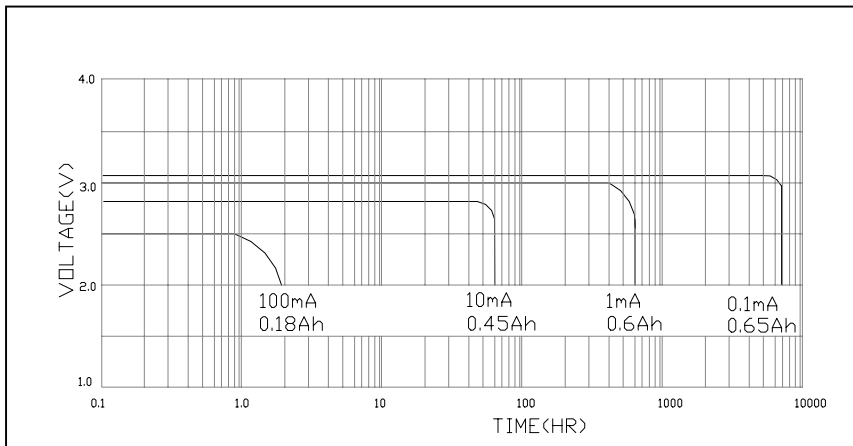

Warning:

- .Do not short-circuit;
- .Do not recharge, force over-discharge, assemble / disassemble and crush; risk of fire and burns;
- .Do not use under temperature above specified range